

### FEATURES

- SMALL SIZE AND SURFACE MOUNTABLE
- HIGH CURRENT AND LOW DC RESISTANCE CHARACTERISTICS
- BOTH FLOW AND REFLOW SOLDERING APPLICABLE
- HIGH INDUCTANCE AVAILABLE IN SMALL SIZE
- EMBOSSED PLASTIC TAPE PACKAGE FOR AUTOMATIC PICK-PLACE

**RoHS Compliant**  
includes all homogeneous materials

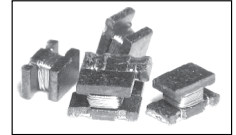

\*See Part Number System for Details

Specifications	NLQ25	NLQ32	NLQ35	NLQ45
	1008	1206	1210	1812
Inductance Range	1.0 $\mu$ H ~ 33 $\mu$ H	0.12 $\mu$ H ~ 100 $\mu$ H	0.15H ~ 560 $\mu$ H	1.0 $\mu$ H ~ 470 $\mu$ H
Temperature Range (Including Self-Heating)	-25°C ~ +125°C			
Temperature Rise at Irms	40°C max.			
Inductance Change at Irms	-10% typical			
Inductance Tolerance	10% (K) 20% (M)	10% (K) 20% (M)	10% (K) 20% (M)	10% (K) 20% (M)
Resistance to Solder Heat	260°C for 5 seconds			

Series	Case Size	A	B	C	D	E
NLQ25	1008	2.50 ± 0.2	2.00 ± 0.2	1.80 ± 0.2	0.15 min.	0.8 ± 0.2
NLQ32	1206	3.20 ± 0.3	1.60 ± 0.3	1.80 ± 0.3	0.15 min.	1.15 ± 0.2
NLQ35	1210	3.20 ± 0.3	2.50 ± 0.3	2.20 ± 0.3	0.15 min.	1.15 ± 0.2
NLQ45	1812	4.50 ± 0.3	3.20 ± 0.3	2.60 ± 0.5	0.15 typ.	1.75 min.

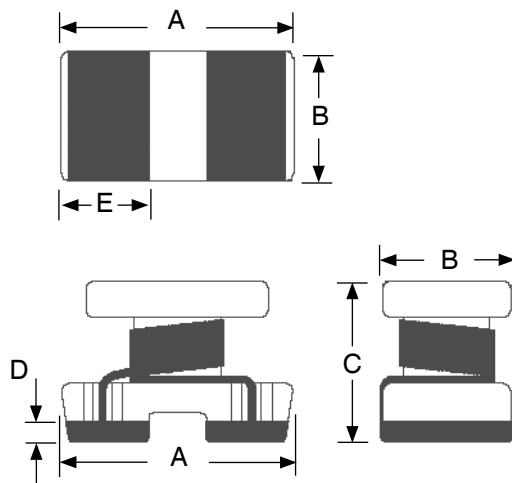

### PART NUMBER SYSTEM

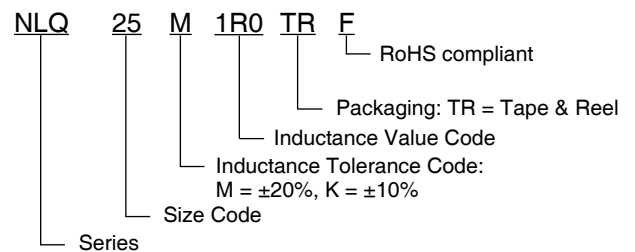

Part Number	STANDARD VALUES - CASE SIZE 25 (2.5 x 2.0 x 1.8mm)				Test Frequency
	Inductance Value (μH)	DC Resistance (Ω)	I <sub>rms</sub> (mA)	SRF (MHz) min.	
NLQ25M1R0TRF	1.0 ± 20%	0.422	475	200	7.96MHz
NLQ25M1R5TRF	1.5 ± 20%	0.546	435	165	
NLQ25M2R2TRF	2.2 ± 20%	0.650	390	95	
NLQ25M3R3TRF	3.3 ± 20%	0.845	340	55	
NLQ25M4R7TRF	4.7 ± 20%	1.040	285	43	
NLQ25M6R8TRF	6.8 ± 20%	1.300	275	39	
NLQ25K100TRF	10 ± 10%	2.197	210	32	2.52MHz
NLQ25K150TRF	15 ± 10%	2.860	175	21	
NLQ25K220TRF	22 ± 10%	3.640	160	18	
NLQ25K330TRF	33 ± 10%	5.460	120	16	

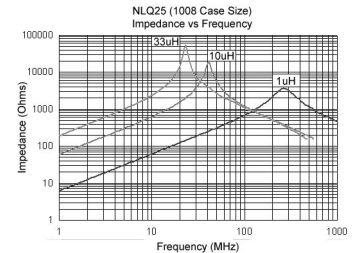

Part Number	STANDARD VALUES - CASE SIZE 32 (3.2 x 1.6 x 1.8mm)				Test Frequency
	Inductance Value (μH)	DC Resistance (Ω)	I <sub>rms</sub> (mA)	SRF (MHz) min.	
NLQ32MR12TRF	0.10 ± 20%	0.112	970	250	1MHz
NLQ32MR22TRF	0.22 ± 20%	0.140	850	250	
NLQ32MR47TRF	0.47 ± 20%	0.210	700	180	
NLQ32M1R0TRF	1.0 ± 20%	0.364	510	100	
NLQ32M2R2TRF	2.2 ± 20%	0.533	430	50	
NLQ32M4R7TRF	4.7 ± 20%	0.845	340	31	
NLQ32K100TRF	10 ± 10%	1.690	230	20	
NLQ32K220TRF	22 ± 10%	3.900	160	14	
NLQ32K470TRF	47 ± 10%	10.40	100	10	
NLQ32K101TRF	100 ± 10%	15.60	80	7	

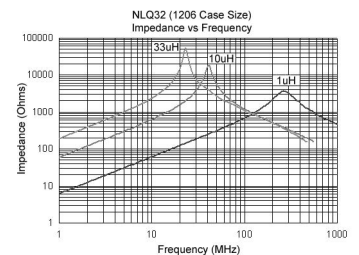

Part Number	STANDARD VALUES - CASE SIZE 35 (3.2 x 2.5 x 2.2mm)				Test Frequency
	Inductance Value (μH)	DC Resistance (Ω)	I <sub>rms</sub> (mA)	SRF (MHz) min.	
NLQ35MR15TRF	0.15 ± 20%	0.028	1450	400	1MHz
NLQ35MR27TRF	0.27 ± 20%	0.034	1250	250	
NLQ35MR47TRF	0.47 ± 20%	0.042	1100	150	
NLQ35M1R0TRF	1.0 ± 20%	0.117	800	96	
NLQ35M2R2TRF	2.2 ± 20%	0.169	600	64	
NLQ35M4R7TRF	4.7 ± 20%	0.260	450	43	
NLQ35K100TRF	10 ± 10%	0.572	300	26	
NLQ35K180TRF	18 ± 10%	0.852	270	20	
NLQ35K220TRF	22 ± 10%	0.923	250	19	
NLQ35K330TRF	33 ± 10%	1.235	220	14	
NLQ35K470TRF	47 ± 10%	1.690	170	15	
NLQ35K101TRF	100 ± 10%	4.550	100	10	
NLQ35K221TRF	220 ± 10%	10.92	70	6.8	
NLQ35K271TRF	270 ± 10%	11.85	66	4.5	
NLQ35K331TRF	330 ± 10%	13.00	60	5.6	
NLQ35K391TRF	390 ± 10%	22.10	60	5	1KHz
NLQ35K471TRF	470 ± 10%	24.70	60	5	
NLQ35K561TRF	560 ± 10%	28.60	60	5	

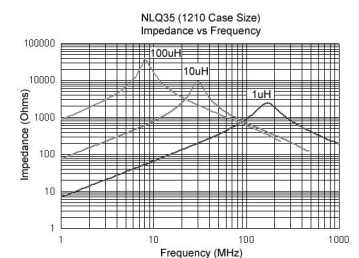

Part Number	STANDARD VALUES - CASE SIZE 45 (4.5 x 3.2 x 2.6mm)				Test Frequency
	Inductance Value (μH)	DC Resistance (Ω)	I <sub>rms</sub> (mA)	SRF (MHz) min.	
NLQ45M1R0TRF	1.0 ± 20%	0.08	1080	100	1MHz
NLQ45M1R5TRF	1.5 ± 20%	0.09	1000	85	
NLQ45M2R2TRF	2.2 ± 20%	0.11	900	60	
NLQ45M3R3TRF	3.3 ± 20%	0.14	800	47	
NLQ45M4R7TRF	4.7 ± 20%	0.15	750	43	
NLQ45M6R8TRF	6.8 ± 20%	0.20	720	30	
NLQ45K100TRF	10 ± 10%	0.24	650	23	
NLQ45K150TRF	15 ± 10%	0.32	570	20	
NLQ45K220TRF	22 ± 10%	0.60	420	15	
NLQ45K330TRF	33 ± 10%	1.00	310	12	
NLQ45K470TRF	47 ± 10%	1.10	280	10	
NLQ45K680TRF	68 ± 10%	1.70	220	8.4	
NLQ45K101TRF	100 ± 10%	2.20	190	6.8	
NLQ45K151TRF	150 ± 10%	3.50	130	5.5	
NLQ45K221TRF	220 ± 10%	4.00	110	4.5	
NLQ45K331TRF	330 ± 10%	6.80	100	3.6	
NLQ45K471TRF	470 ± 10%	8.50	90	3.0	
					1KHz

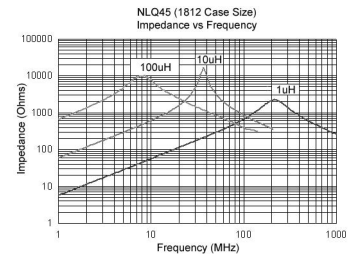

Case Size	LAND PATTERN DIMENSIONS (mm)		
	L	G	H
NLQ25	2.5	0.9	2.0
NLQ32	3.2	1.0	1.6
NLQ35	3.2	1.0	2.5
NLQ45	4.5	1.5	3.2

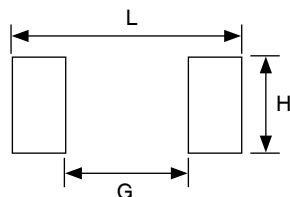

### REFLOW SOLDERING PROFILE

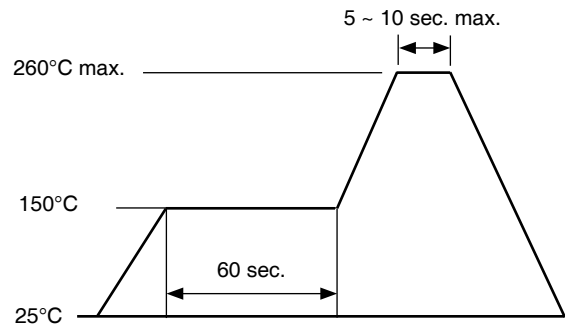

Case Size	Reel Qty	CARRIER TAPE DIMENSIONS (mm)						
		W	A0	B0	Co	K0	Po	t
NLQ25	2,000	8.0	2.20 ± 0.1	2.75 ± 0.1	3.50 ± 0.05	2.00 ± 0.1	4.0 ± 0.1	0.22 ± 0.05
NLQ32	2,000		2.40 ± 0.1	3.50 ± 0.1		2.55 ± 0.1		0.26 ± 0.05
NLQ35	2,000		2.67 ± 0.1	3.65 ± 0.1		2.50 ± 0.1		
NLQ45	500	12.0	3.50 ± 0.1	4.98 ± 0.1	5.5 ± 0.05	3.05 ± 0.1	8.0 ± 0.1	

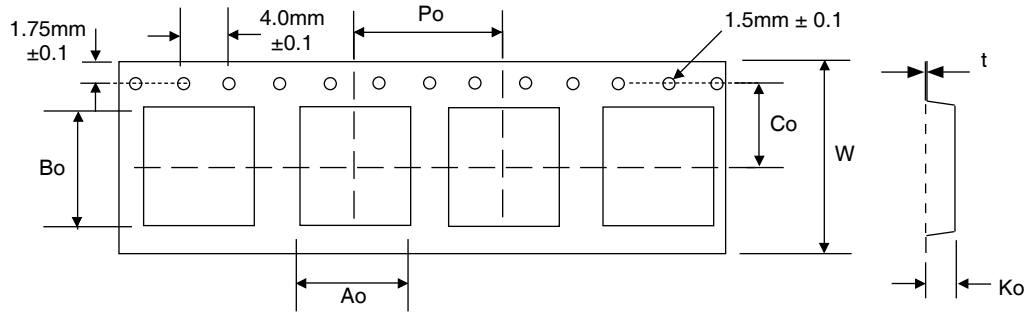

Tape Width	REEL DIMENSIONS (mm)			
	A(mm)	B(mm)	C(mm)	D(mm)
8mm	8.5 ± 0.1	100 ± 1	13.0 ± 0.5	330
12mm	12.5 ± 0.1			

